



# ÀRATIS

THE PERFORMANCE LEADER IN EXTERIOR LIVING SPACE

NOW INCLUDING:

**DURATECH**<sup>®</sup>  
CAPPING TECHNOLOGY



The front porch is where we meet. It's where we greet our friends and loved ones. It's where we make first impressions. It's where we play, we relax and it's where we dream.

Your front porch isn't just an extension of your house, it's an extension of you.

By choosing Aeratis PVC porch products, the proven performance leader, not only will it make an elegant first impression for generations to come, it has the flexibility to make an impression that's distinctly *you*.

Whether you like the look of stained and finished wood, or prefer the traditional look of a painted porch floor, Aeratis has a product that's right for you.







IT'S NOT JUST AN EXTENSION OF YOUR HOUSE  
...it's an extension of you.



## Aeratis Features

- › An elegant finished-floor look
- › Can be painted or left natural
- › For covered and uncovered porches
- › No ventilation requirements
- › Installs with staples, nails or screws
- › Cuts like wood and can be routed
- › Approved for historic restoration
- › Can be made waterproof
- › Can be installed over concrete
- › Mold resistant and will not rot
- › Can be made water-tight
- › Dimensionally stable
- › Meets W.U.I. Requirements
- › ADA slip-compliant
- › Stain resistant
- › Limited Lifetime Warranty

See website for complete details by product



A long, bright, covered walkway with white columns and a dark metal railing, leading towards a lush green landscape. The walkway is made of light-colored concrete or stone. The railing is dark metal with a repeating diamond pattern. The columns are white and cylindrical. The background shows a large tree with a thick trunk and green foliage. The sky is bright and overcast. The overall atmosphere is clean, modern, and serene.

WE MAKE IT LIKE THEY USED TO  
...only better.



Historically, the porch was an extension of the grand entrance. Architects, builders and homeowners understood that a seamless transition between the porch and the entryway was a natural part of the design.

Timbers were rough cut to 1 inch thick. They were then milled on site to their correct shape and planed down for a smooth finished look, never left with a deep wood grain like most other types of decking available today.

This smooth finished size was 7/8" x 3 1/8", the exact dimensions of Aeratis Porch Flooring, making it the only product perfect for a historic restoration or for a new porch designed with historical accuracy.



## Aeratis vs. Wood

Today's wood porches rot.

When homes were built in the early 1800's, the majority of the timbers used for porch flooring were cut from old-growth forests. This means that the trees were grown to a ripe old age before being cut and milled.

This type of growth allowed the wood timbers to be much more dense than the young, quick-cut timber we have available on the market today. In an effort to make more profit in less time, mills today harvest wood that is far less dense and rush it from the forest to the lumber yard.

Lumber plays an important role in many aspects of today's building industry. Porch flooring is just no longer one of them.





PERFORMANCE IS OUR  
...advantage.



The porch floor environment poses unique challenges for whatever material is used. It's an area with very little ventilation, where hot air and sun bake the surface in the summer, while significantly cooler air is trapped underneath the floor. The opposite holds true in the wintertime.

This dramatic swing in temperature, combined with moisture collecting on the underside and humidity up above, causes inferior products to bow, cup, split, and compromise their dimensional stability. The expansion alone of other synthetic porch floor products has caused massive failures nationwide.

The strength and durability of Aeratis is proven to be far superior to all other options on the market. Aeratis has been the product of choice for porches on commercial, government and public works projects nationwide because of the dimensional stability, the virtual elimination of annual maintenance, and ADA slip compliance. See our third party test results to learn more.





## Aeratis Traditions

is an uncolored, paint-ready board that is designed specifically for those who want the look of a traditional painted porch floor.

Consider this... with the amount of R&D going into today's paint products, the paint itself is really not the issue. The issue comes from what is being painted. With the proprietary formulation of Aeratis Products, you can have the color you want without the maintenance, and with our paint ready Traditions line, you can achieve this goal for nearly the same price as wood.

When painted with one our recommended paints, Traditions has a 5-A paint adhesion, making it the perfect solution for those who want a low-maintenance porch in the color of their choice.

Repaint cycles vary based on usage and climate, however the average repaint cycle is every 7 to 10 years in high traffic areas.

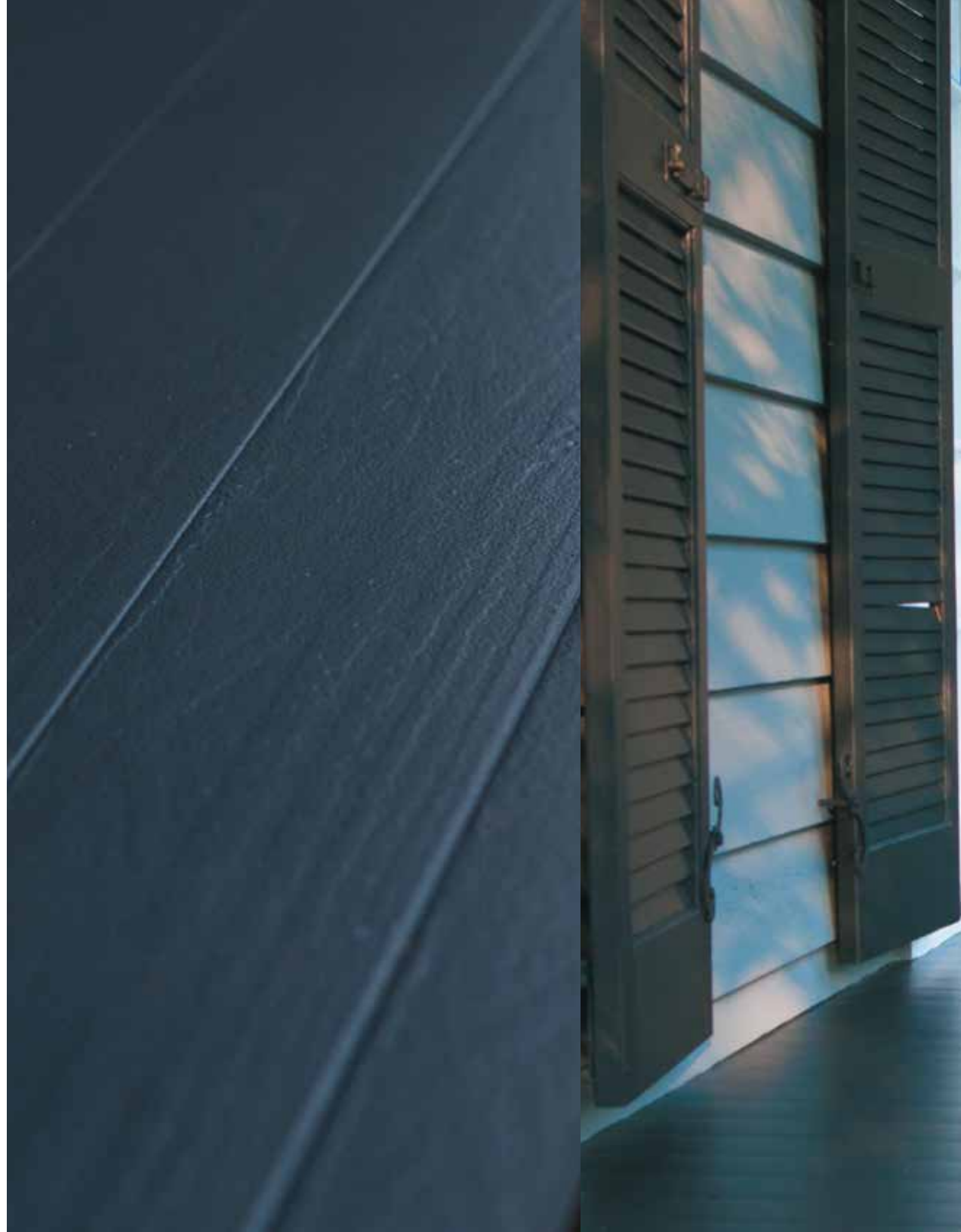



A photograph of a porch with white columns and a dark deck, overlooking a garden with a brick fire pit and trees. The scene is captured in bright, natural light, highlighting the textures of the wood, brick, and foliage. The porch has a dark, possibly black or dark brown, deck. To the left, there's a white door with a brass handle and a black lantern-style light fixture mounted on the wall. The porch is supported by several white, fluted columns. In the background, there's a lush garden with green grass, a brick fire pit, and various trees and shrubs, some with autumn-colored leaves. The overall atmosphere is bright and inviting.

DREAM IN COLOR  
...any color.



## Aeratis Heritage & Legacy

comes in three pre-finished colors, designed to match the warmth and beauty of a finished wood plank.



# DURATECH<sup>®</sup>

CAPPING TECHNOLOGY

## Heritage and Legacy now with DuraTech<sup>®</sup> Capping Technology

DuraTech<sup>®</sup> Capping Technology is the result of 5 years of research and development with a focus on form and function. This revolutionary acrylic based cap is color matched with the core, making the cap virtually invisible. The DuraTech<sup>®</sup> cap's surface rivals all available options in both hardness and slip resistance. In addition to a harder and more slip resistant surface, the color retention is second to none and is backed by Aeratis' Limited Lifetime warranty.

**Color Consistency** – Depending on the look to be accomplished for the exterior living space, many property owners considered color consistency to be mission critical. With the Aeratis DuraTech<sup>®</sup> capping technology, not only is the product consistent from board to board, it is color consistent from year to year and across multiple batches and runs. Our product is a virtually maintenance free PVC product with an acrylic cap. If your project demands the appearance of a painted front porch with just enough of a wood grain





showing through, Aeratis Heritage and Legacy are the perfect products for your exterior living space.

**Slip Resistant** – Being on the go is a part of life in today's busy world. Whether it is a party with 100 guests or serving lunch to the family on a lazy Sunday afternoon, life causes us to move constantly. When you are on the go on your porch or balcony, the last thing anyone wants to think about is slipping and falling, especially just after a rain or in the morning after the dew has fallen. With Aeratis' revolutionary DuraTech® capping technology, you will experience surface hardness like no other wood or synthetic product coupled with the most slip resistant surface on the market.

**Color Retention / Fade Resistant** – When designing the perfect exterior living space, the look, feel and color pallet should stay beautiful for many years to come. It is critical to the designed space that all the colors not only, match the first time it is used, they should all match for as long as the design style stays popular. With all of this in mind, Aeratis engineered the most color-fast and fade resistant acrylic based capping system in the industry. This cap will not only endure the normal wear-n-tear of everyday use, it will withstand the harshest of direct UV exposure.

**Double Sided** – Every porch plank made by Aeratis is double sided. Whether the project calls for exposed joist or the customer is unforgiving on dings and nicks from transportation damage. Aeratis has engineered a product that offers options. If one side of an Aeratis board has transportation damage, simply flip the board over to expose the other side prior to installation.

**Scuff and Stain Resistant** – Acrylic surfaces are some of the hardest surfaces used today. We see acrylic used in high traffic/high use areas everywhere. When engineering the DuraTech® technology, use and appearance was our highest priority. With the advancement in this technology, Aeratis is now 10X more stain and scuff resistant.

**Authentic Appearance** – For well over a 15 years, Aeratis has been known for providing the highest performing products for exterior living space. However, the vast majority of Architects, Builders, and property owners who have selected Aeratis for their projects have stated they chose it because of the authentic appearance compared to wood. Aeratis has been approved for use in almost every state for National Register and Historic Places replacement due to the likeness to the wood products it is meant to replace.

# Aeratis Heritage



Battleship Gray

Weathered Wood

Vintage Slate

Aeratis Heritage is a color-through T&G PVC porch plank which has been enhanced with subtle, natural color variation along with a slight grain texture to mimic the richness and depth of wood. It is designed to look like a painted or stained wood floor. This historically accurate double-sided profile offers greater flexibility for installers and a finished look to the underside of your porch. Heritage is ADA slip compliant and has been engineered to withstand extreme weather conditions. Visit [Aeratis.com](http://Aeratis.com) to request a quote or learn about the complete line of Aeratis products and latest installation details.

Heritage comes in 3 lengths, 12', 16' and 20'. Each board is about 1' longer than the stated length to allow both ends to be squared and still have true length board.

Aeratis Heritage comes in three pre-finished colors. Heritage can be painted, stained, or left natural. The three colors available are Weathered Wood, Battleship Gray, and Vintage Slate.

## Color Match Trim



1" x 7/8"

Chamfer nosing



7/8" x 7/8"

Quarter-round

Aeratis also offers traditional, color-matching trim profiles to finish the edge of your porch including quarter-round and chamfer nosing in 8' lengths.

### Painted Quarter-Round



Battleship Gray Chamfer





## Heritage Universal Porch Plank

The Aeratis Universal Porch Plank, or UPP, is a 5-1/2" x 7/8" x 12' PVC plank specifically engineered to be used in conjunction with all of the Aeratis T&G porch planks or as a stand-alone product. The Universal Porch Plank comes in Battleship Gray, Vintage Slate, Weathered Wood, and our proprietary paint-ready formula.

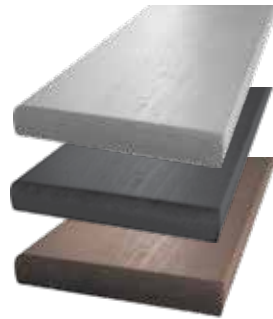

One corner of the board has the unique feature of a pre-finished routed edge, while the other three edges are 90° corners, offering more versatility in your designs. The pre-finished bullnose provides the finishing touch for the lead edge of stairs or a seamless picture frame. If the pre-finished bull-nosed edge is not desired, simply flip the board over for a square-edge look.

For stair applications, make sure the bullnose is facing out on the lead edge of the stairs. On the inside board that touches the riser, make sure the bull-nosed edge is facing down and to the rear of the stair riser. This will provide the appearance of a T&G surface while providing a very small gap that will allow water to escape.

## Aeratis Heritage Testing Data

Performance Characteristic	ASTM Method	Results
Flame Spread	ASTM E84	Class B or better
ADA Slip Test	ASTM F1679	.82 dry/.72 wet
Coefficient of Expansion	ASTM D696	1.91 x 10 <sup>-5</sup> in/in/°F
Compression Parallel Shear	ASTM D198	2605 psi
Screw Withdrawal	ASTM 143	2939 psi
Decay Resistance	ASTM D1761	806 lbs
Termite Resistance	ASTM D1413	No Decay
Weatherability - 2000 hours	ASTM D3345	10 - Highest Rating
50 Cycle Freeze Thaw	ASTM D2565	91% of Baseline MOR
Water Absorption	AC 174	93% of Baseline MOR
Modulus of Rupture	ASTM 570	1.21%
Modulus of Elasticity	ASTM D6109	16" O.C. - 3,000
	ASTM D6109	16" O.C. - 370,000

## Universal Porch Plank Profiles

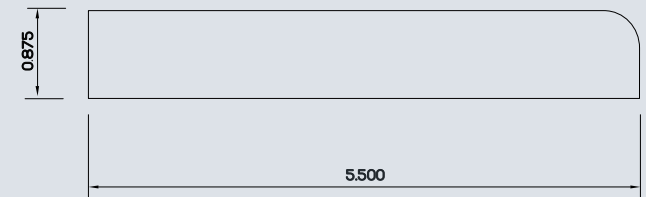

### Stair Application

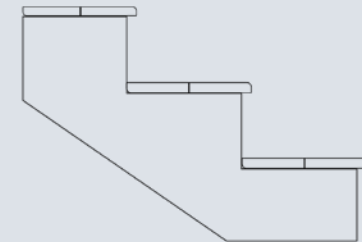

## Aeratis Heritage Profiles

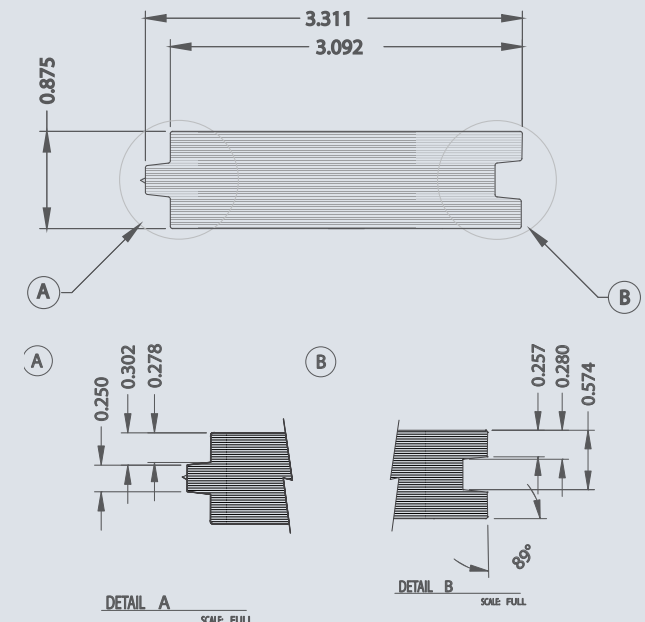

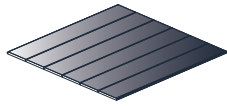

# TRADITIONS

## PAINT-READY PORCH FLOORING

Aeratis Traditions is an uncolored board that can be painted or stained in any color. Unlike the Heritage line, which can also be painted, Traditions must be painted in order to take advantage of the industries' unparalleled warranty. When painted or stained, Aeratis Traditions maintains a 5-A paint adhesion, the strongest paint adhesion in the industry (no priming needed). This means that you can enjoy the same low-maintenance porch that matches the look and feel of your home in a color that's right for you, with a 20-year warranty. See Aeratis.com for complete painting and staining instructions.

Notice the dramatic difference between the wood for the early 1900's compared to the wood from today. Notice the growth rings or the lack thereof from the wood harvested in 2018. This is the result in quick cut timber practices. This is why wood porches have to be maintained and replaced so often. These costs can add up very quickly. Aeratis has introduced Aeratis Traditions as a true wood replacement. Competitively



Photo by: Zack Deltmore

priced to wood at the time of install, can be painted any color with an average repaint cycle of 7-10 years, FREE paint in the form of a rebate and is backed by a Lifetime Limited warranty. Stop trying to use wood on your porch and turn to the Performance Leader in Exterior Living Space and stop worrying about your porch.



Paint-Ready T&G Porch Flooring

## What is Traditions?

Aeratis Traditions is a paintable or stainable line of porch products priced competitively to wood while providing the superior performance of a PVC product. Once painted or stained, Traditions products are indistinguishable from traditional wood, offering you greater design flexibility at a competitive price with a far superior paint or stain adhesion (5-A adhesion - the highest possible within ASTM standards).



## TRADITIONS TWENTY-FOUR

### Porch Ceiling & Wainscoting

Aeratis Traditions Twenty-Four beaded ceiling/ Wainscoting is a historically accurate, double sided, paint-ready PVC ceiling product. The Traditions Twenty-Four ceiling board dimensions are 5" x 3/8" x 16'. What makes the Traditions-24" ceiling board unique is the fact that it is the only synthetic that can be installed with the ceiling joist 24" OC. Further, the ceiling board can be painted any color due to the nature of our proprietary paint grade formulation (see paint instructions and paint rebate at Aeratis.com). The Traditions-24" ceiling board not only saves time and money during the installation process, it dramatically reduces the overall construction cost due to the significant advantage of the 24" OC span rating over every other synthetic on the market (the only 24" OC install in it's class).



1-1/4" beaded plank (side 1)



2" beaded plank (side 2)





## Traditions Trim

Aeratis also offers paint-ready traditional trim profiles to finish the edge of the porch and hide termination points. These trim pieces include quarter-round, half-round nosing, and chamfer nosing in 8' lengths. When using trim pieces to finish up your Traditions paint-ready porch floor, any color of trim will work. Everything made by Aeratis can be painted or stained and a 5-A

paint adhesion can be achieved. Simply, clean the trim pieces (and porch flooring) with acetone after all caulking and holes are filled and paint with an Aeratis approved paint (see aeratis.com for complete painting instructions and list of approved paints).

## Traditions Universal Porch Plank

The Aeratis Traditions paint-ready Universal Porch Plank is perfect for picture framing your Traditions installation, using on stairs, or even as a stand alone wide-plank porch application. Follow the same painting instructions as the porch planks (see painting instructions at Aeratis.com).



## Aeratis Traditions Testing Data

Performance Characteristic	ASTM Method	Results
Flame Spread	ASTM E84	Class B or better
Coefficient of Expansion	ASTM D696	191 x 10 <sup>-5</sup> in/in/°F
Compression Parallel	ASTM D198	2605 psi
Shear	ASTM 143	2939 psi
Screw Withdrawal	ASTM D1761	806 lbs
Decay Resistance	ASTM D1413	No Decay
Termite Resistance	ASTM D3345	10 - Highest Rating
Water Absorption	ASTM 570	1.21%
Modulus of Rupture	ASTM D6109	16" O.C. - 3,100
Modulus of Elasticity	ASTM D6109	16" O.C. - 362,000

## Aeratis Traditions Profiles

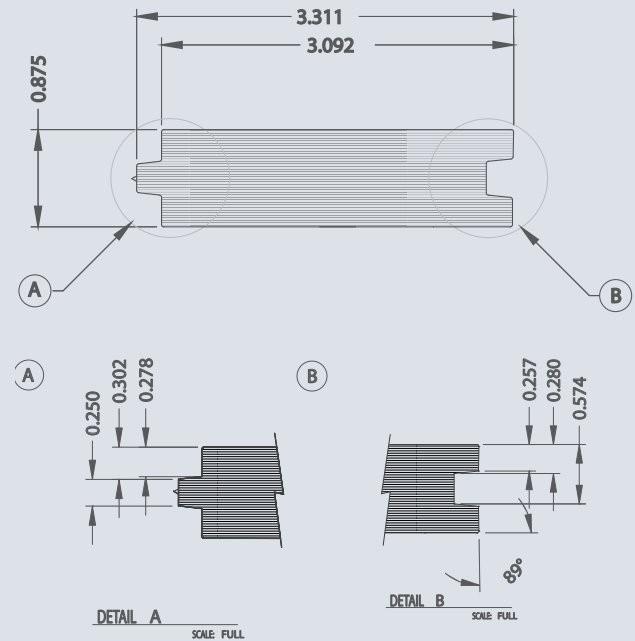

## Traditions - 24" Ceiling Profile

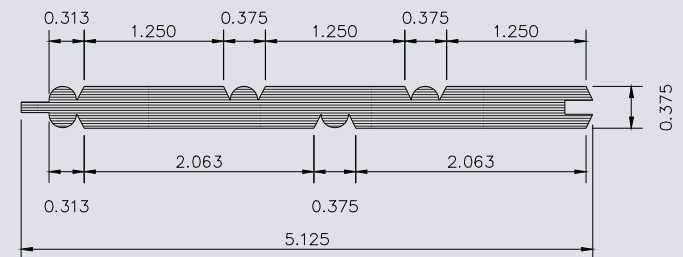



# Aeratis Legacy

Aeratis Legacy is a 6" wide T&G porch plank. This board was engineered to match the wider planks used on many porches in the early 1800's. The wider plank not only cuts the installation time in half, it provides a richness and beauty that could only be found on historic homes crafted before the 1900's. The Aeratis Legacy product comes in 3 colors: Battleship Gray, Weathered Wood and Vintage Slate. The actual dimensions of the board are 6" wide, 7/8" thick and comes in 12', 16' and 20' lengths.

When considering the overall value and aesthetics of a porch, many property owners consider using a radius edge deck board in a porch application. This can cause a few issues on top of the fact that, aesthetically, a deck board with gaps should never be used in a porch application. One of the issues with there being gaps between the boards is it allows moisture to pass in-between the boards and this can lead to moisture problems underneath the entire structure. In addition, the lack of ventilation underneath a porch and direct sun on the surface can cause many deck boards to swell and buckle.

All too often property owners look at the cost per square foot of a deck board and compare it to a 3-1/8" wide tongue and groove board and they choose to use the deck board due to cost savings. With the introduction of the Aeratis Legacy product, and it's built in hidden fastener system property owners can receive the cost savings from installation as well as a more competitive cost per square foot. Couple these two items with the known performance characteristics and Aeratis Legacy becomes the clear choice when considering which product to use on exterior living space.

# Aeratis Classic

Aeratis Classic comes in three pre-finished colors, with subtle, natural color variation to mimic the richness and color depth of wood. It is designed to look like an unpainted, finished wood floor. The three colors available are Weathered Wood, Vintage Slate, and Battleship Gray. The Classic line is our flame-resistant line and is a special order item.

## Aeratis Legacy Profiles

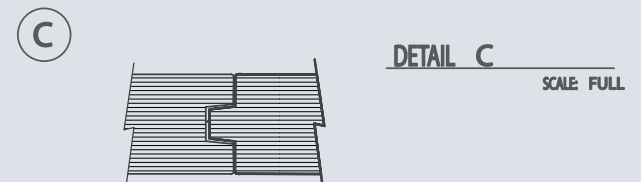
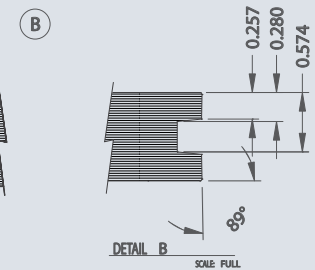
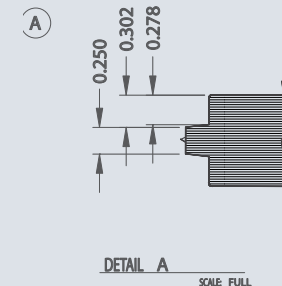



## Porch Flooring Installation and Application

Due to the dimensional stability of Aeratis, we offer the widest range of acceptable installations in the industry. To name a few, low or no ventilation installs, waterproof installs, direct to concrete, over standard joist system, directly over a membrane, and both covered and uncovered applications. Aeratis is a high performance material with a life expectancy that far surpasses wood and other synthetics. Before installing, follow a few simple recommendations and guidelines, found at Aeratis.com, and if this is done, greater satisfaction can be achieved.



**ES# 380** Check local and national building codes before installing Aeratis. Aeratis meets ALL national and local requirements for installation on residential, commercial, and government applications. For best results, install Aeratis porch flooring with a pneumatic flooring nailer. When selecting the right fastener, check to see which fastener is recommended by the treated wood or substrate that the fastener will be penetrating. For best results on a standard joist installation, we recommend using a 2" stainless steel or galvanized staple along with a urethane based construction adhesive. Make sure your joists adhere to national building codes and are 16" OC.



For best results, run the Aeratis T&G boards perpendicular to the structure or the desired direction of water run-off. Installing boards perpendicular to the structure are not only more aesthetically pleasing, they will promote water run-off from wind-blown rain and when a large volume of water is used to clean siding, windows and ceiling boards.

With just a little planning it is possible to virtually eliminate maintenance on your porch floor. Please be sure to visit Aeratis.com and review the installation instructions. The guidance provided on the website will help insure a perfect install.

## Beaded Ceiling Installation and Application

For years, many people believed that the most difficult environment for a product to perform was on the porch floor. The porch floor is a tough environment due to the lack of ventilation, high exposure to moisture, and heavy use. However, getting a porch ceiling to perform has been what seemed to be an insurmountable task until now. Aeratis has introduced the only synthetic that can be installed on a span rating of 24" OC and painted any color. This is by far the most dimensionally stable synthetic product on the market.



Installing this product is as simple as installing the Aeratis T&G porch floor. The best fastener for installing the beaded ceiling product is either a galvanized or stainless fastener (check with the substrate manufacturer/treater for best fastener material). For best results and for all 24" OC installations, use a bead of construction adhesive on the substrate just prior to fastening the ceiling board. The Aeratis Beaded Ceiling boards can be installed parallel or perpendicular. If the boards are installed and a butt joint is used, make sure the joints are glued and fastened over a ceiling joist and not left free-floating.

Before installing the Aeratis Beaded Ceiling/Wainscoting, review all installation requirements and best practice items. The installation instructions provide the best possible installation method that will insure longevity of the Aeratis product installed.

A photograph of a window on a light blue house with horizontal siding. The window is covered with dark blue PVC shutters. The shutters have a louvered design. The window frame is white. There are some green plants in front of the window.

CUSTOM PVC  
SHUTTERS





## Shutter Styles



Bahama



Louver



Radius Top



Panel



## Aeratis Custom Shutter Features

- Fraction of the cost of wood
- Fully operable
- Historically accurate
- Approved for historic restoration
- Will not rot
- Will not warp
- Termite resistant
- Customize with 6 cuts of a saw
- Paint any color
- Paint rebate included
- Includes stainless steel hardware
- Limited lifetime warranty
- Assemble in less than 30 minutes
- Radius top available
- Louver or Raised Panel

Technology is tackling the tough areas of outdoor living spaces.

## Custom Shutters for any budget with a Limited Lifetime Warranty

Aeratis now offers custom, historically accurate, operable, PVC shutters with a limited lifetime warranty for a fraction of the cost of wood shutters. These shutters can be purchased one of the following 3 ways:

- 1) **In a box and ready to size, assemble, paint and install.** At this amazingly low price, assembly and painting is required. If you can commit to about 30 minutes and have the skill to use a miter saw and screw gun, you can save hundreds of dollars with each pair of shutters over using wood shutters.
- 2) **Assembled and ready to paint and install.** Ready to Paint? You can order Aeratis Louver or Raised panel shutters pre-assembled to the size you need. When the shutters arrive, each pair of shutters are ready to paint and install on your window.
- 3) **Painted and ready to install.** Yes, it is true! Aeratis Custom louver and raised panel shutters can be ordered a custom size painted and ready to install. Simply visit your local lumberyard or visit [Aeratisshutters.com](http://Aeratisshutters.com) and request a quote.

Aeratis PVC Shutters are engineered with the same technology that has made our T&G porch flooring the performance leader for over 15 years. Aeratis Shutters are not only backed by a Limited Lifetime Warranty, they are engineered to out-perform wood, polypropylene, polyethylene and aluminum shutters for a fraction of the cost.

Each shutter component profile is an exact replica of shutters dating back to the early 1800's. These operable shutters offer an architectural detail that will not only enhance the value of the property, but will provide lasting, worry-free beauty.

Now, you have real options and depending on time and budget, you can now own operable shutters with a Lifetime Limited warranty and not spend thousands of dollars. With the Aeratis shutter offering, you can purchase either Louver Shutters or Raised Panel shutters.







## Shutter Options

For many years, there has been only two options for shutters. The first and most expensive is the wood options. Typically, these shutters are made from cedar and are custom sized for your opening. They can be ordered raw, primed or finished. When these are purchased, the hardware must also be purchased with the shutters. These shutters can be very expensive and offer a very limited value because they typically are accompanied by little to no warranty.

The second option for shutters has been the plastic bolt to the wall shutter that comes in a few standard sizes. These shutters scream they are fake. They present to the viewer of the home that these shutters could not close. This is due to the fact that they are a standard size and are never wide enough to cover the window opening.

Both of these choices pose challenges, and neither are great options. We understand this, and for this reason, we engineered the Aeratis Custom shutter program. With the Aeratis shutter product line, you will get a historically accurate, operable pair of shutters that are accompanied with stainless steel hardware and a Lifetime Limited warranty. Yes, these shutters open and close and come with stainless-steel rust-free hardware. So, not only do Aeratis shutters come with a Limited Lifetime warranty, but you can get them in a box, ready to assemble, and ready to paint and install. Or, you can order them completely finished and ready to be installed once they arrive. No matter how you order them, they cost must less than wood shutters and will beautify your house much better than a plastic set of bolted to the wall shutters.

Request a quote today or visit a local lumber yard and review and Aeratis Shutter Display and you will see why Aeratis Custom Shutters were the chosen partner of This Old House.

AS SEEN ON  
This Old House

**Louver Shutters** – Aeratis Custom Louver shutters are engineered to visually mimic a louver shutter from the early 1800's with far superior performance characteristics. Each shutter, when closed, provides the privacy of a standard louver shutter while allowing air to flow through the louvers. With a life expectancy of just over 220 years and with a 70 year repaint cycle rating, this is truly a custom shutter, with millions of color options without the maintenance of wood. Out of the box, the louvers are not adjustable, however, you can order either the faux tilt rod to add to the shutters or you can order the adjustable louver shutters pre-assembled.

**Raised Panel Shutters** – Aeratis panel shutters come either pre-assembled a custom size and ready to paint or assembled a custom size and are finished and ready to install. There are a couple of different options for the panels. Panel shutters can be ordered with a beaded raised panel or a standard raised panel. In both cases, the panel shutter face is flush with the face of the stiles and rails. Please note: one side of the shutter is raised, and the other side is flat.

For panel shutters, all stiles and rails are made from the Aeratis shutter PVC formulation. The panels of the shutters are made from Exteria, a Jeldwin panel material for exterior use.

**Custom Sizes** – Aeratis custom shutters can be assembled any size for an inside or outside mount (Mounting the shutter inside the window or on the outside of the window, when the shutter is closed.) Literally, with six cuts of a miter saw, an Aeratis shutter can be made any size. Aeratis shutters are sold in 3', 5', 7' and 10' heights. This allows you to purchase the shutter closest to the height of your window and then trim the height and width down to the exact size.

**Shutters-in-A-Box** – Custom shutters in a box seems like an odd concept. However, consider that each shutter is over-sized and with six cuts of a miter saw, the shutter can be customized to fit any size window. Aeratis Custom Shutters-In-A-Box come 3', 5', 7', and 10' tall and each shutter, if assembled right out of the box, is 21" wide. Each box comes with a pair of shutters and will cover an opening 42" wide. Each box also includes all the assemble screws and all the hardware needed to hang and hold the shutters open. With Aeratis Custom Shutters In-A-Box, the concept is really easy; One window one box of shutters. Simply measure the height of the window and select the shutter that is just taller than the window opening.





## Shutters In-A-Box Sizes

Aeratis Shutters can be purchased in a box ready to assemble, paint and install. This is the most cost-effective way to purchase Aeratis shutters. Typically, the cost runs about a 1/3 of the price of cedar shutters and only takes about 30 minutes to assemble and even less time to paint if you can spray the shutters. The boxed shutters come un-assembled or knocked down in the box. With 6 cuts of a miter saw, some glue and 12 screws, you can customize these shutters to fit just about any opening. Aeratis shutters heights are 3', 5', 7', and 10' tall. All shutters are 21" wide out of the box and will cover a 42" opening.

DESCRIPTION	HEIGHT	SINGLE SHUTTER WIDTH	PAIR WIDTH
3' Pair of Shutters In-A- Box	37"	21"	42-1/4"
5' Pair of Shutters In-A- Box	61"	21"	42-1/4"
7' Pair of Shutters In-A- Box	85"	21"	42-1/4"
10' Pair of Shutters In-A- Box	121"	21"	42-1/4"



Top Rail Width: 2-1/2" x 1-3/8"



Stile Width: 2-1/2" x 1-3/8"



Bottom Rail  
Width: 4-1/4" x 1-3/8"



Mid Rail Width: 2-1/4" x 1-3/8"



12" Bottom/Top Rail  
Width: 12" x 1-3/8"



## Eliminate Lead-time and Save

Assembly of a pair of Custom Shutters should take less than 30 minutes. Due to how this system is engineered, it saves time and money, not to mention that these shutters will out-perform wood, plastic-bolt-to-the-wall shutters and aluminum. This system offers the best quality, the lowest cost, and they are available to purchase at a local lumber yard and install today. Waiting 4-6 weeks can be very costly to a project, especially if your custom wood shutters arrive damaged or the wrong size. With Aeratis Custom Shutters In-A-Box system, there is no lead-time and the size is always right.

# Shutter Assembly

## Custom Shutters in 6 Cuts

The Aeratis Custom Shutters In-A-Box system was engineered to provide historically accurate, operable shutters without the lead-time and with minimum assembly requirements. With just 6 cuts of a miter saw, an Aeratis Shutter can be cut down to fit any window. First, cut all 3 rails together. Next, cut all 4 stiles together. Finally, cut as many louvers as the saw being used will allow. The assembly process was created to allow all levels of craftsmen to be able to create the artistry and accuracy typically only found in a millwork shop.

## Simple Assembly

At Aeratis.com we offer a complete library of videos to help with the installation, cutting, and assembly of all Aeratis products. Once all of the shutter components are cut to the right size, assembly is a snap with only a couple of steps. First, identify the mid-rail placement to match the window. Second, insert the louvers into the stiles. Next, pre-drill, glue and fasten the components with the screws that are provided. Finally, fill the holes and paint the shutters the desired color.

## Shutter Painting Instructions

Every product that is produced by Aeratis can be painted. There is a major advantage when painting the Aeratis family of products. When using a tested and approved paint and following the painting instructions, the industries' strongest adhesion can be achieved. This means the painted product may not need to be re-painted for many years to come.

With the Aeratis custom shutters, there is no guess work on how to paint and achieve the industries' strongest paint adhesion. Simply assemble the shutter, fill all holes, and either spray or brush the shutters any desired color.





# Shutter Component Profiles

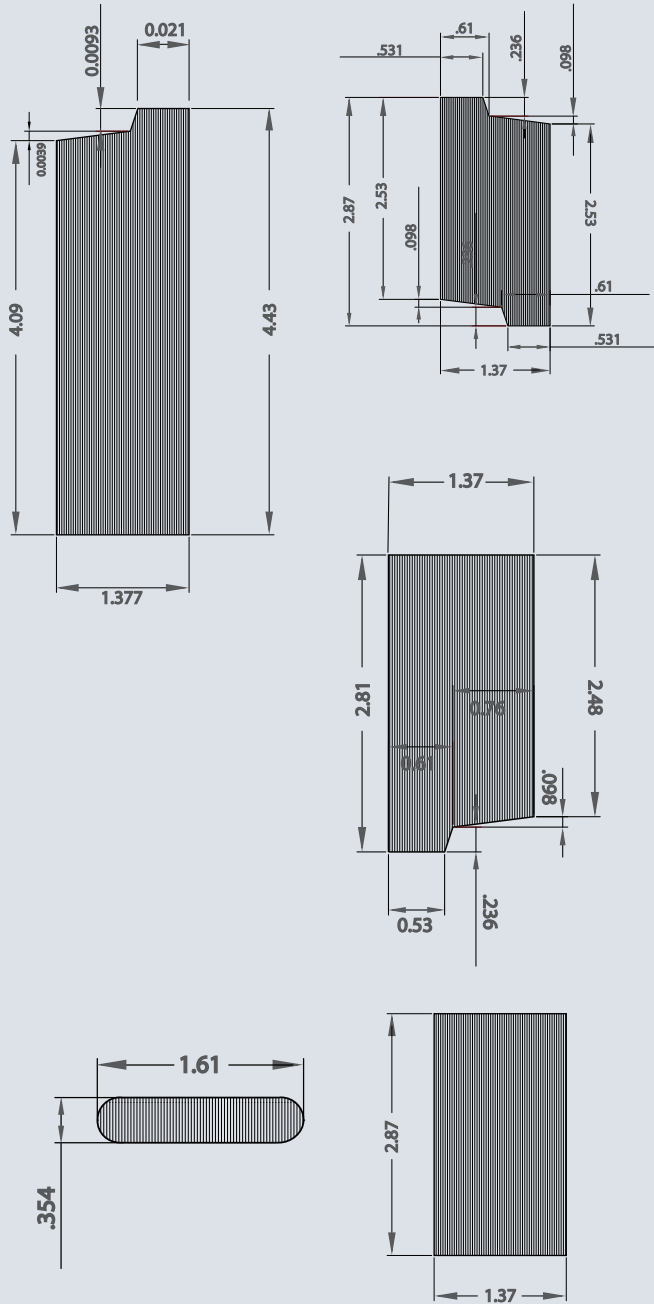

# Shutter Hardware and Installation

## Surface Mounting

It is not recommended to bolt any shutter directly to the wall and not provide airspace behind the shutter. It is always best to have airflow between the wall surface and the shutter. This allows this area to dry after a rain and reduces issues that come from snow and ice build up. With the Aeratis Custom Shutters In-A-Box all the mounting hardware is provided in the box for mounting the shutters the best possible way for longevity.

If the shutters must be mounted without the hardware, make sure to add a spacer to the mounting screws to keep the shutters at least 1-1/2" away from the wall on the side that is closest to the window. Try to keep the side of the shutter away from the window at least 1" when mounting. This will help maintain the appearance of having operable shutters. Not only will this help maintain the appearance of having operable shutters, but will also provide the spacing needed to allow moisture to dry and further allow snow and ice to pass behind the shutters.

## Shutter Mounting Options

Surface installation (included in box)

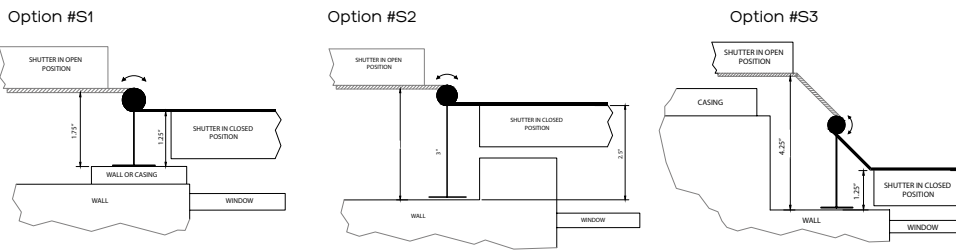

Recess installation

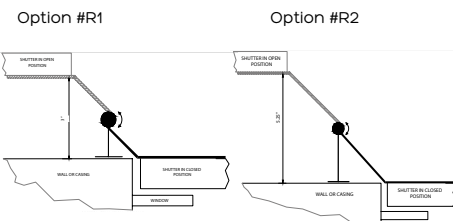

Decorative installation

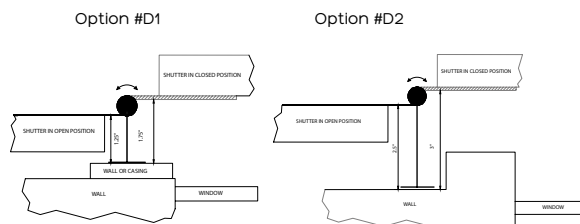

## Custom Shutter Hardware

### New York Style Hinge

The New York Style "L" Hinge and Pintles are the most common hinges sold for operable shutters. All Aeratis custom shutters In-A-Box come with stainless-steel New York "L" hinges, pintles and also includes a mid-hinge for 3', 5', 7' shutters and 2 pairs of mid-hinges for 10' shutters. These hinges will not rust and will allow the shutters to open and close. All Aeratis New York style hinges are made of stainless-steel as are the screws to mount and secure the hinges to the shutters. All shutter hardware is powder-coated black and is scratch resistant.



Aeratis custom shutters In-A-Box are meant to be surface mounted. If the shutters need to be mounted inside the window area, a different set of hinges with the correct offset will need to be purchased separately.

Included in the box: 2 left hand hinges, 2 right hand hinges, 4 pintles, and stainless-steel screws.  
Aeratis Stainless-Steel Hinge Offset: 0",  
Aeratis Stainless-Steel Pintle Offset: 1-1/4"

### New York Style Mid-Hinge

Aeratis Mid-hinges are made of stainless-steel and are powder-coated black. These are also included with every pair of shutters and provide additional support for the Aeratis custom PVC shutters. All Aeratis shutters are required to have mid-hinges. All shutters over 7' must have 2 mid-hinges.



Included in the box: 2 mid-hinges (4 mid-hinges for 10' shutters)



## Pintle Shims

Pintle shims are included with each pair of shutters. These shims are used to either increase the offset or help level the surface of the siding or wall face. Pintle shims are installed behind the pintles. These pintle shims are black, made of plastic and are 1/4" thick.

Included in the box: 6 pintle shims  
(8 for 10' shutters)



## Scroll Shutter Dogs

Each pair of Aeratis shutters include an aluminum scroll dog, stainless steel lag bolt and our patent pending scroll dog shutter support. The Scroll Dog is aluminum and all lag bolts are stainless-steel. The shutter support is placed over the lag bolt and adds additional support to your custom Aeratis shutters. All Scroll Dogs and lag bolts are powder-coated black.

Included in the box: 2 scroll dogs, lag bolts, washers, cotter pins, and 2 shutter supports with set screws.



## Aeratis Lull & Porter Hinges

The Aeratis Lull & Porter hinge is a special-order hinge. These hinges are made of zinc-alloy, will not rust and are powder-coated black. The Lull & Porter hinges are essential in areas of historic significance. Each zinc-alloy hinge is mortised into the edge of the shutter and the window casing. This hinge is designed to hold the shutter in the open position without needing shutter dogs but will need the shutters supports.

Set Includes: 2 Pairs of Lull & Porter hinges

### SIZES AND THROW FROM CASING:

Width	Throw	Offset	Material
4-1/2"	2-3/4"	1-3/8"	Zinc-Alloy





# ÆRATIS

PVC PORCH FLOORING

p. 888-676-2683

[products@aeratis.com](mailto:products@aeratis.com)

[www.aeratis.com](http://www.aeratis.com)    [www.porchpro.com](http://www.porchpro.com)

[www.aeratisshutters.com](http://www.aeratisshutters.com)

PROUD PARTNER OF

